

REPORT No. 620

PRESSURE DISTRIBUTION OVER AIRFOILS WITH FOWLER FLAPS

By CARL J. WENZINGER and WALTER B. ANDERSON

SUMMARY

Pressure-distribution tests were made of a Clark Y airfoil with a 0.20c_w Clark Y Fowler flap and of an N. A. C. A. 23012 airfoil with 0.20c_w, 0.30c_w, and 0.40c_w N. A. C. A. 23012 Fowler flaps. Some of the tests were made in the 7- by 10-foot wind tunnel and others in the 5-foot vertical wind tunnel. The pressures were measured on the upper and lower surfaces at one chord section both on the main airfoils and on the flaps for several angles of attack with the flaps located at the maximum-lift settings. A test installation was used in which the model was mounted in the wind tunnel between large end planes so that two-dimensional flow was approximated.

The data are given in the form of pressure-distribution diagrams and as plots of calculated coefficients for the airfoil-and-flap combinations and for the flaps alone. The pressure-distribution tests show that the effect of increasing the chord of the Fowler flap, for a given lift of combined airfoil and flap, is to increase the portion of the total load carried by the flap and to decrease the adverse pressure gradients of the main airfoil and thereby its tendency to stall. The maximum values of the normal-force coefficient of the Fowler flap were found to be much smaller than previously indicated and approximately the same as those of the external-airfoil flap and of the simple split flap. The flap-load data given in this report supersede those given in Report No. 534.

INTRODUCTION

The Fowler flap in combination with a main airfoil appears to be one of the most effective high-lift devices investigated up to the present time. Previous investigations of this device (references 1, 2, and 3) have shown that it is capable of developing high lift coefficients and that it gives lower drags at the high lift coefficients than do plain or split flaps. The Fowler flap, in addition, differs from the external-airfoil flap in that it is fully retractable for the high-speed-flight condition.

Several sizes of flap combined with a given main airfoil have been investigated, the flap ranging in chord up to 40 percent of the main airfoil chord. (See reference 1.) In addition, tests have been made with these sizes of flap to determine the required locations for each to give its best aerodynamic characteristics.

In order to supply the information requested by designers for structural-design purposes, the present pres-

sure-distribution tests were made to obtain the air-load distribution over the main airfoil and flap. The combinations tested have either the Clark Y or the N. A. C. A. 23012 sections for both the main airfoil and the flap, the flap positions being those giving approximately the highest maximum lift for each arrangement.

APPARATUS AND TESTS

MODELS

Two models, built of laminated mahogany and having a span and chord each of 20 inches, were used for the main airfoils; one was of Clark Y section and the other of N. A. C. A. 23012 section. The upper surfaces of these airfoils from midchord to the trailing edge were formed by a thin steel plate suitably supported by metal ribs at each end and by two intermediate ribs. The space between the plate and the lower surface was filled by wooden blocks cut to the proper contour and arranged for easy removal to form retracting wells for flaps having chords 20, 30, or 40 percent of the main airfoil chord.

Four models (fig. 1) were used for the Fowler flaps, one of Clark Y section and three of N. A. C. A. 23012 section. The Clark Y flap was of brass and had a span of 20 inches and a chord of 4 inches (20 percent of the main airfoil chord). The N. A. C. A. 23012 flaps were of duralumin, each having a span of 20 inches and chords of 4, 6, and 8 inches (20, 30, and 40 percent of the main airfoil chord, respectively). The flaps were supported on the main airfoils by metal fittings at each end and by two intermediate fittings, spaced equally along the span.

A single row of pressure orifices was built into the upper and lower surfaces of each main airfoil and flap at only the midspan section, the tests of reference 4 having shown that other orifices were unnecessary. These orifices were located on the models as listed in table I, the tubes from the orifices being brought through the model and out at one end. The pressures were photographically recorded by a multiple-tube manometer.

TEST INSTALLATION

The entire investigation was originally intended to be made in a single wind tunnel but, because the necessity arose for making changes to that tunnel during the course of the investigation, it was found desirable to

complete the tests in a different tunnel so that the results would not be unnecessarily delayed. Some of the models were tested in the N. A. C. A. 7- by 10-foot open-jet wind tunnel (reference 5) and were mounted as shown by figure 2. The main airfoil was rigidly attached to two circular end plates with the flap set at the position and deflection (30°) giving about the highest $C_{L_{max}}$ of the combination. The end plates were supported in circular cut-outs in two large vertical end planes that extended from top to bottom of the air stream and also some distance ahead of and behind the model. The angle of attack of the model was set by

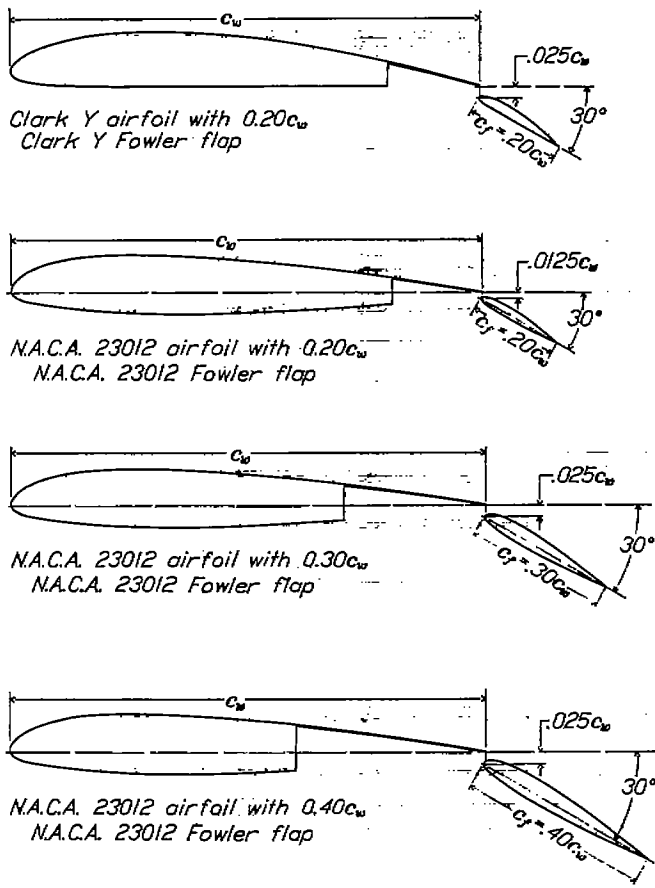

FIGURE 1.—Sections of airfoil and flap combinations tested.

rotating the circular plates and locking them at the desired angle. Approximately two-dimensional flow is obtained with this type of installation and the section characteristics of the model under test may be determined. (See reference 4.)

The remaining models were tested in the N. A. C. A. 5-foot open-jet vertical wind tunnel (reference 6) and were mounted as shown in figure 3. This installation was very similar to that used in the 7- by 10-foot tunnel; the model set-up for testing and the multiple-tube manometer are shown in figure 4.

TESTS

The tests were carried out at a dynamic pressure of 16.37 pounds per square foot, corresponding to an air

speed of 80 miles per hour at standard sea-level conditions. The average test Reynolds Numbers, based on the sum of main airfoil and flap chords, varied from 1,220,000 for the plain airfoil to 1,700,000 for the airfoil with the $0.40c_w$ Fowler flap. The turbulence factor for the 7- by 10-foot open-jet wind tunnel is 1.4 and for the 5-foot vertical tunnel, 1.7, from which the effective Reynolds Numbers may be computed. (Effective

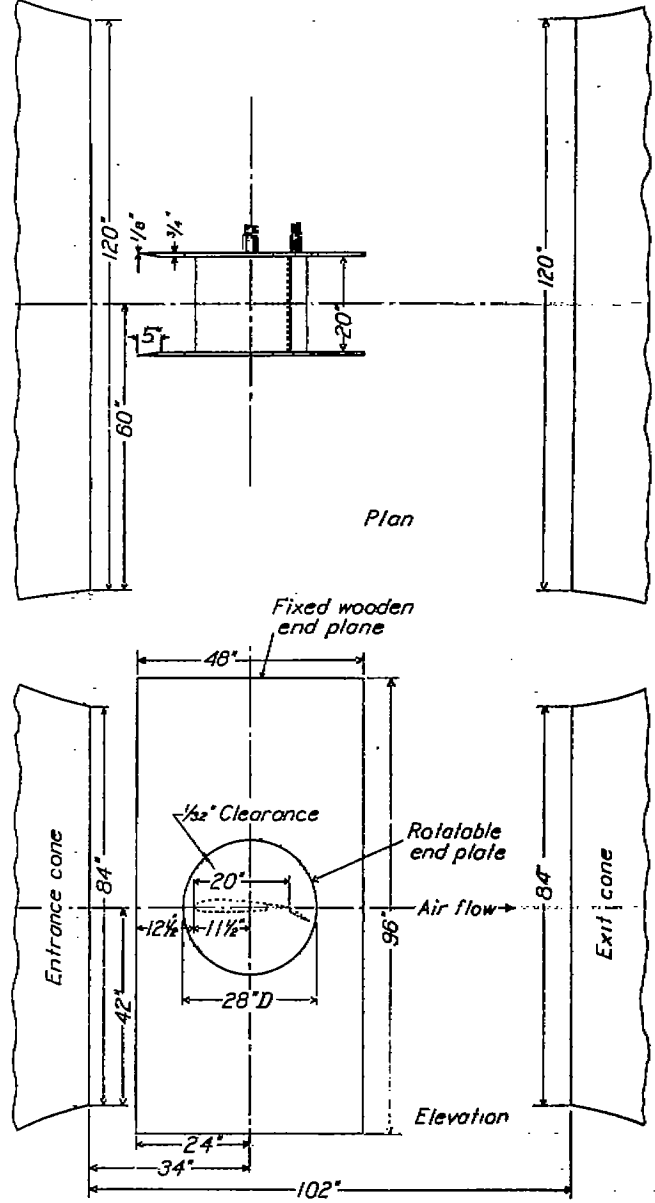

FIGURE 2.—Diagram of model with Fowler flap installed between end planes in the 7- by 10-foot wind tunnel.

Reynolds Number = test Reynolds Number \times turbulence factor (reference 7.)

The Clark Y and the N. A. C. A. 23012 plain airfoils, and the same airfoils with $0.20c_w$ Clark Y and N. A. C. A. 23012 Fowler flaps, respectively, were tested in the 7- by 10-foot wind tunnel. The N. A. C. A. 23012 main airfoil with $0.20c_w$, $0.30c_w$, and $0.40c_w$ N. A. C. A. 23012 Fowler flaps was tested in the 5-foot vertical wind tunnel. All flaps were set at the position and angle

(30°) that gave nearly maximum lift for all the combinations tested. The angles of attack ranged from -20° to 24° and the lift coefficients included those from approximately maximum negative through maximum positive lift. With the model at a given angle of attack, a few minutes were allowed for all test condi-

6) are given as ratios of orifice pressure p to dynamic pressure of the air stream q for the angles of attack investigated. Pressure diagrams for the combinations of main airfoils with Fowler flaps are given in figures 7 to 10 for the various angles of attack tested. On these diagrams the pressures are plotted normal to the main-

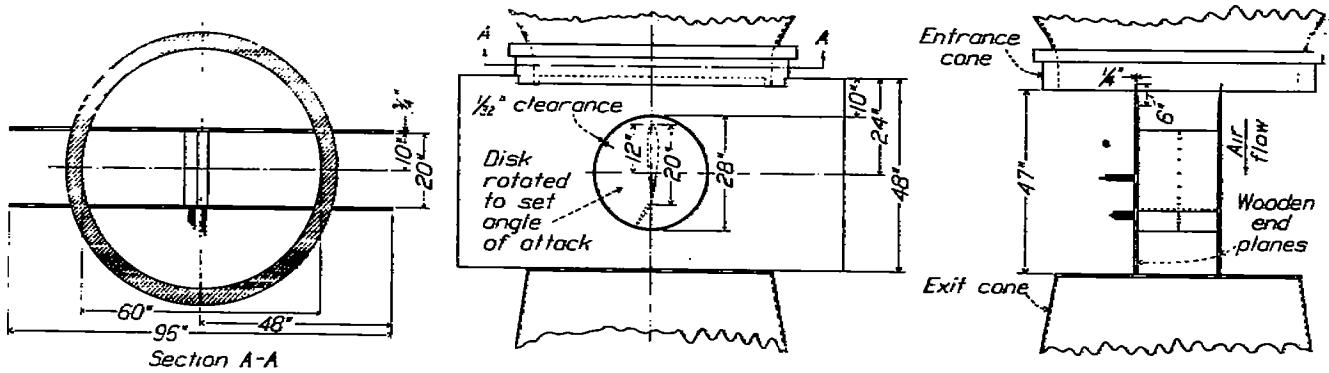

FIGURE 3.—Diagram of model with Fowler flap installed between end planes in the 5-foot vertical wind tunnel.

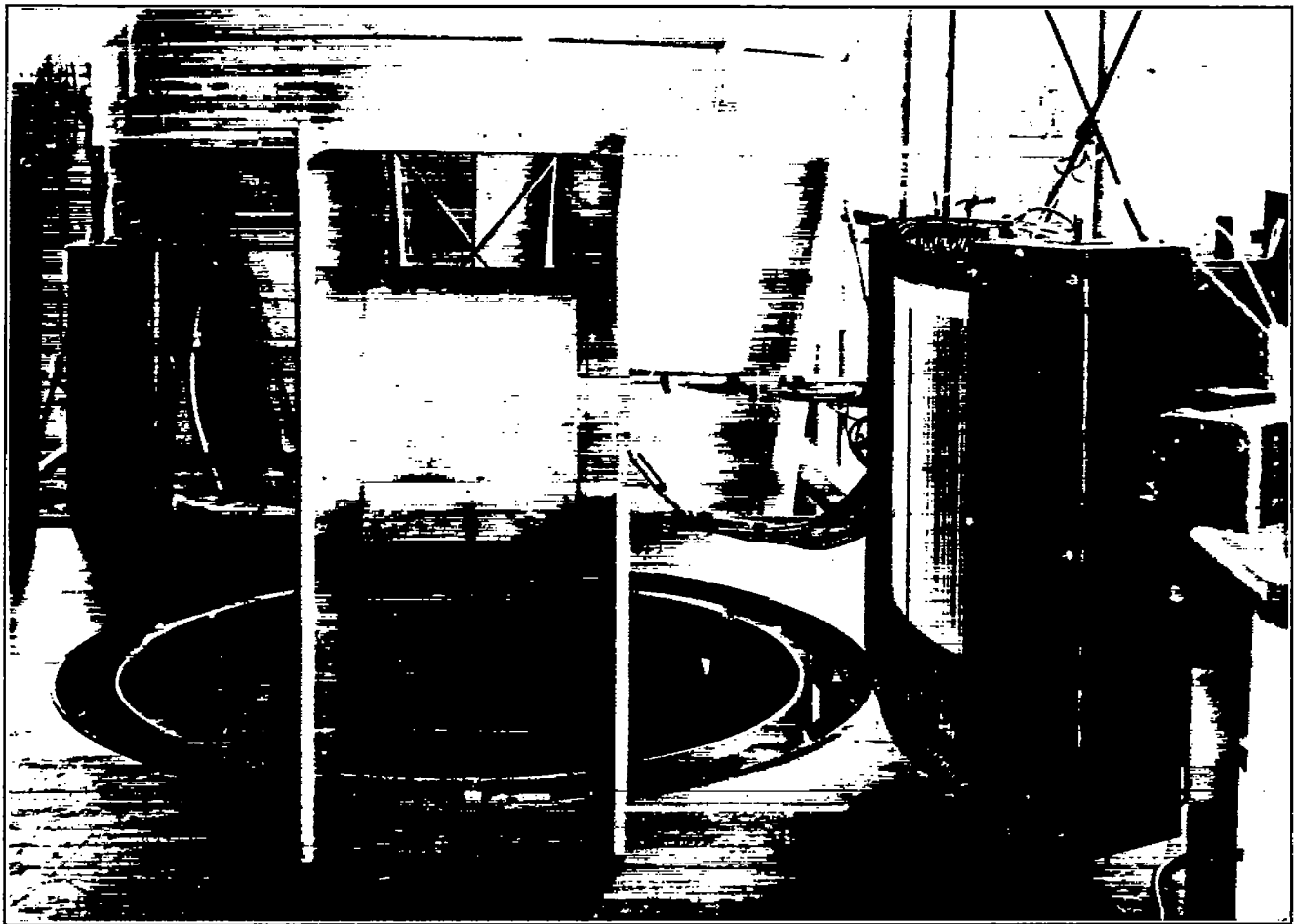

FIGURE 4.—Model and manometer set-up for tests in the 5-foot vertical wind tunnel.

tions to become steady; a record was then taken of the pressures at the orifices by means of the manometer.

**PRESENTATION OF DATA
PRESSURE DIAGRAMS**

Diagrams of the pressures over the upper and lower surfaces of the main airfoils without flaps (figs. 5 and

airfoil chord and to the flap chord, the pressure values being measured from the main chord for the main-airfoil pressures and from the flap chord for the flap pressures. Figures 11 and 12 give comparisons, at the same total lift, of the pressure distribution over the various airfoil-flap arrangements tested.

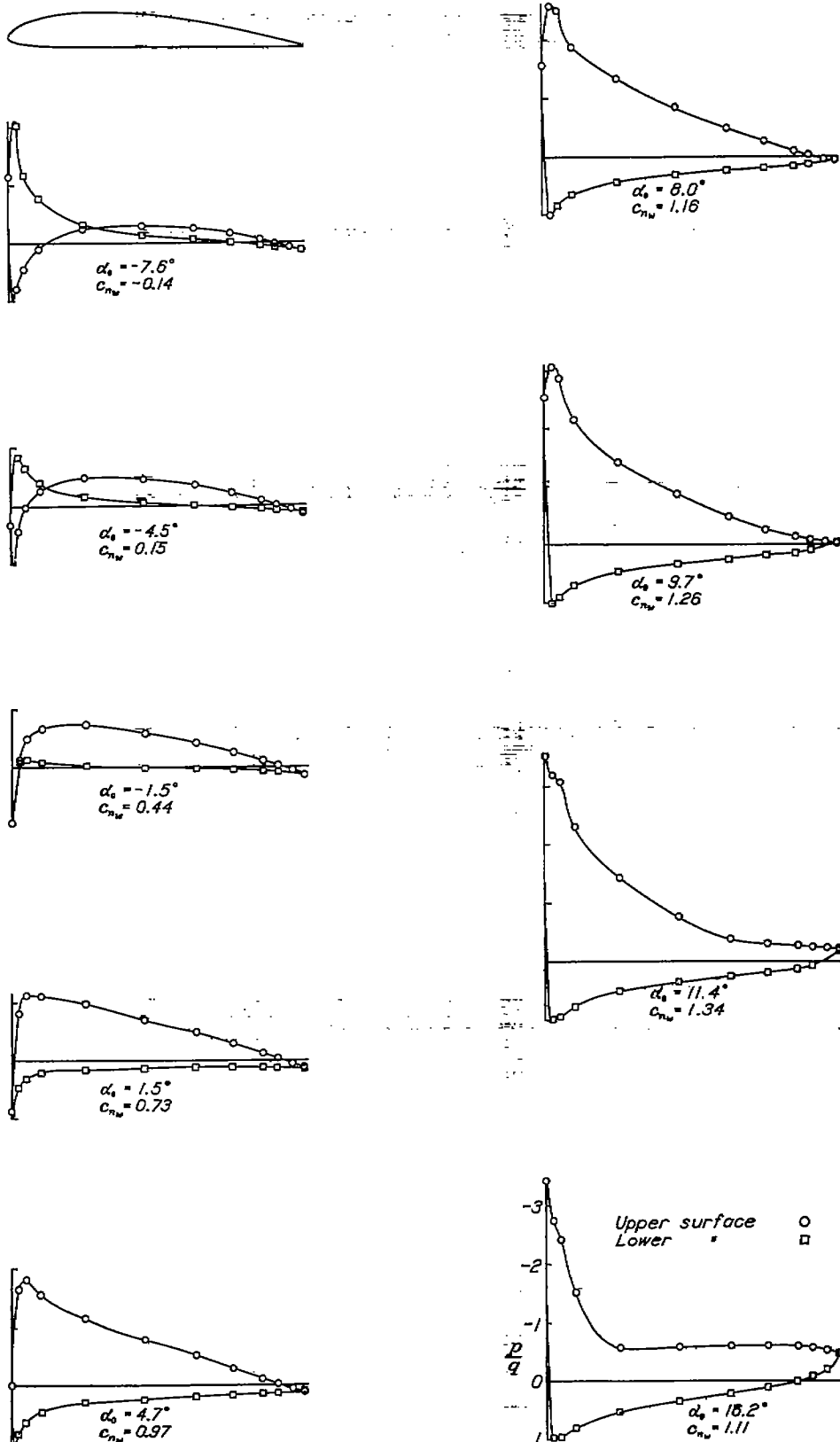

FIGURE 5.—Pressure distribution on the plain Clark Y airfoil, without flap, at various angles of attack.

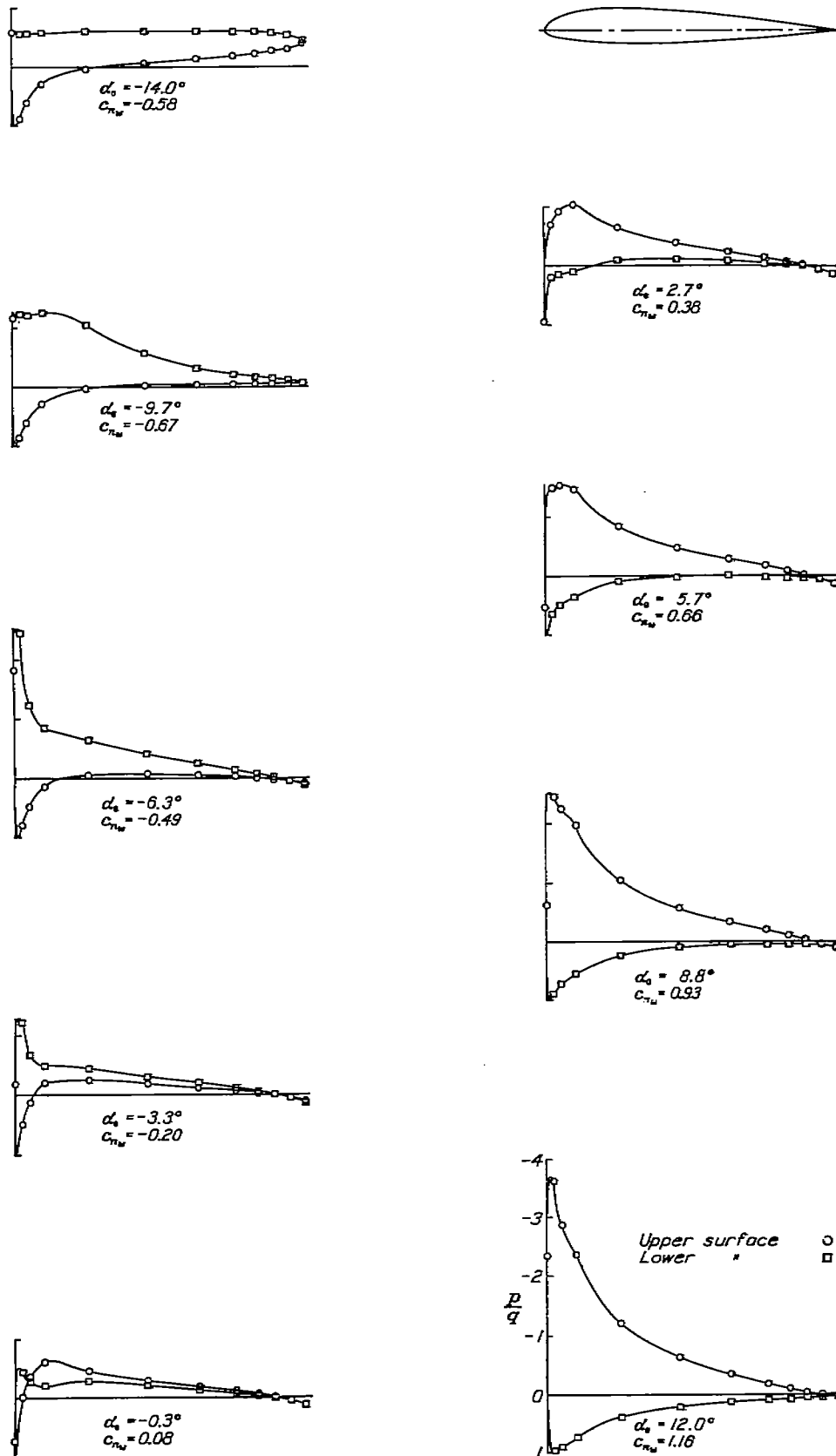

FIGURE 6.—Pressure distribution on the plain N. A. C. A. 23012 airfoil, without flap, at various angles of attack.

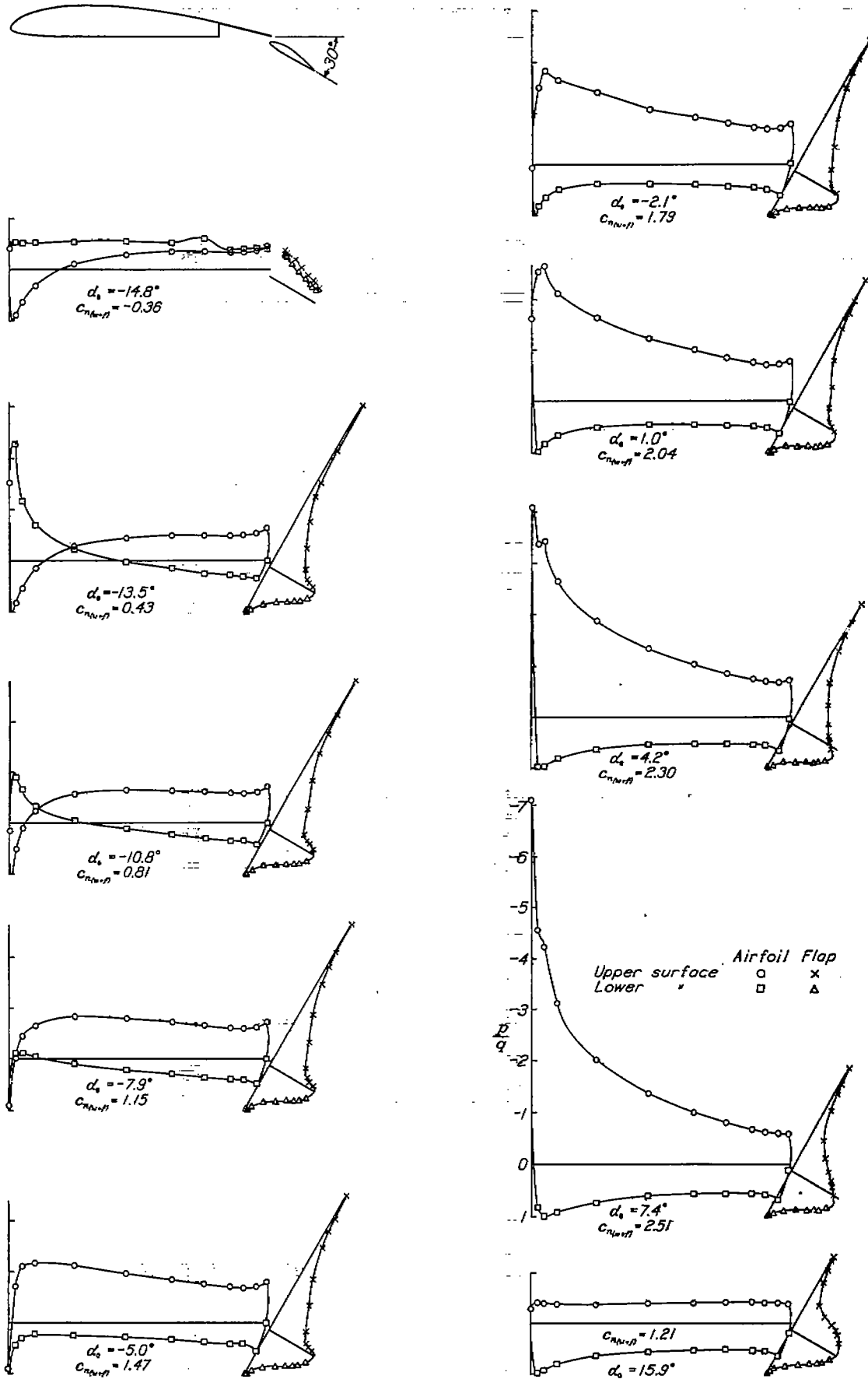

FIGURE 7.—Pressure distribution on the Clark Y airfoil, with the 0.20c Clark Y Fowler flap, at various angles of attack. Flap deflected 30°.

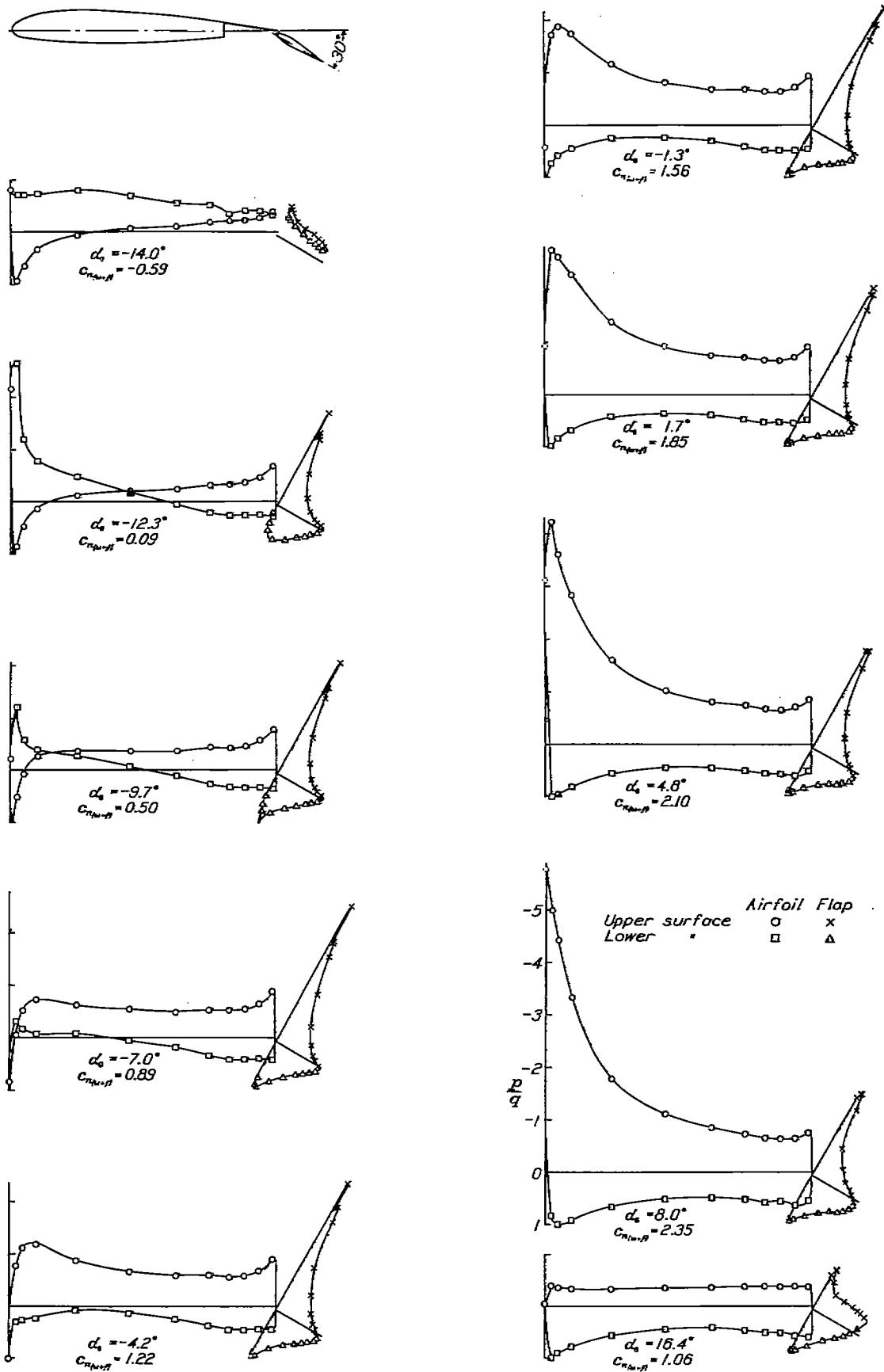

FIGURE 8.—Pressure distribution on the N. A. C. A. 23012 airfoil, with the 0.20 N. A. C. A. 23012 Fowler flap, at various angles of attack. Flap deflected 30°. 189778—39—13

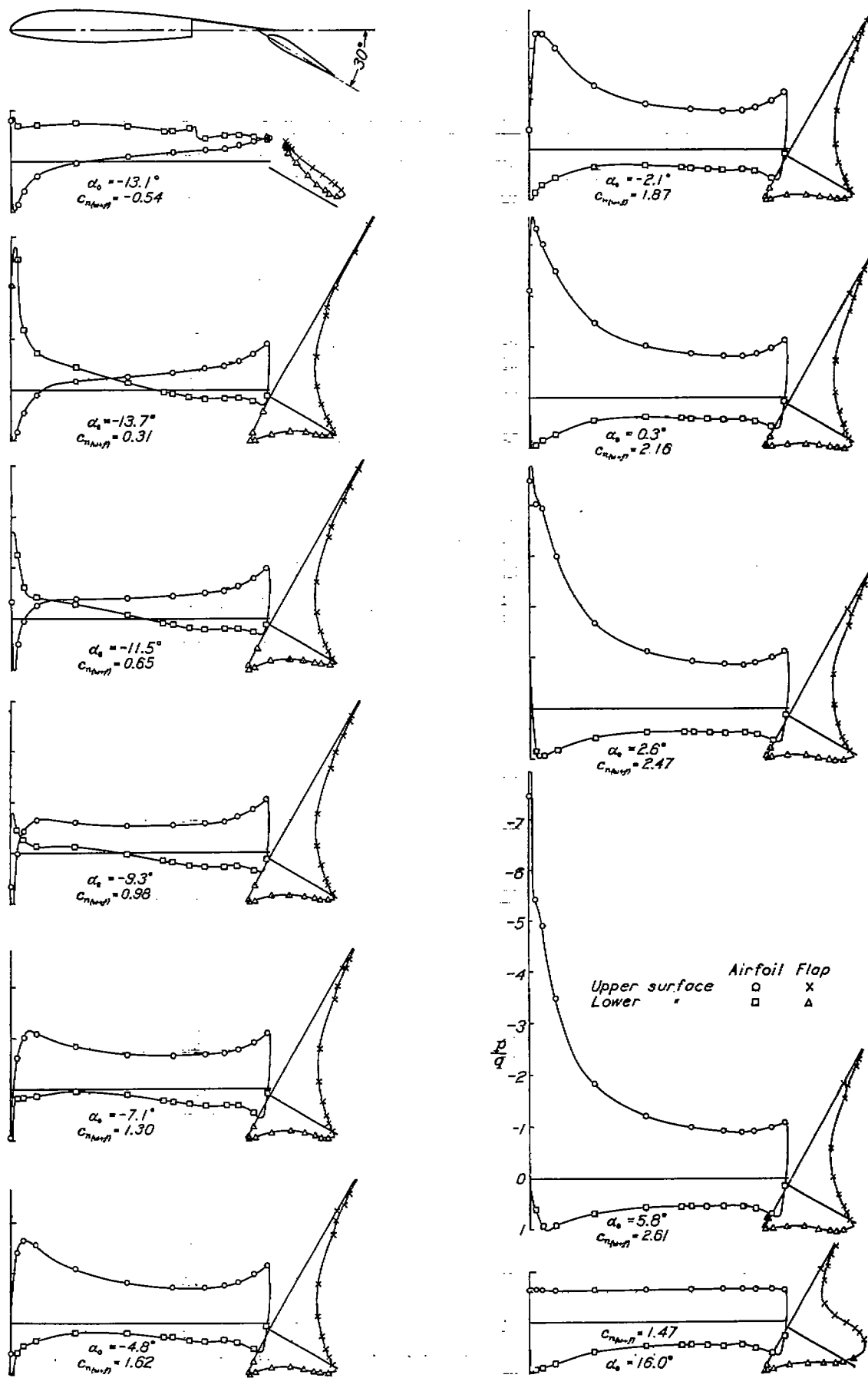

FIGURE 9.—Pressure distribution on the N. A. C. A. 23012 airfoil, with the 0.3c N. A. C. A. 23012 Fowler flap, at various angles of attack. Flap deflected 30°.

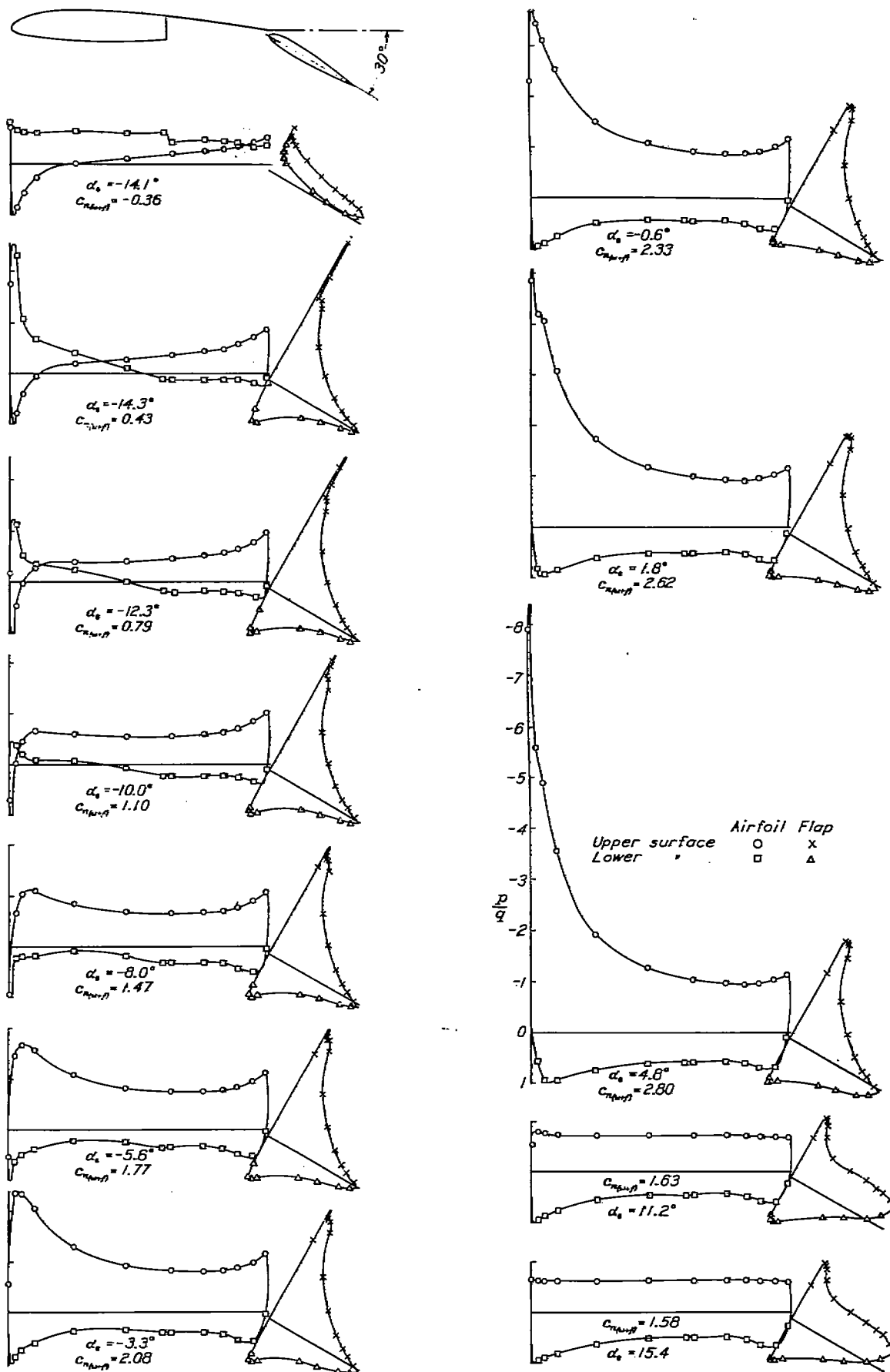

FIGURE 10.—Pressure distribution on the N. A. C. A. 23012 airfoil, with the 0.40c N. A. C. A. 23012 Fowler flap, at various angles of attack. Flap deflected 30°.

In addition to these normal-pressure diagrams, figures 13 and 14 are included to show the pressures parallel to the chords of the $0.30c_w$ and $0.40c_w$ N. A. C. A. 23012 Fowler flaps. These pressures are also given as ratios of orifice pressure to the dynamic pressure of the air stream; however, the pressure values are plotted parallel to, instead of normal to, the flap chord and are measured from the maximum thickness line of the flap, instead of from the chord line.

$$c_{n(w+f)} = \frac{n_{(w+f)}}{qc_w}, \text{ normal-force coefficient of main airfoil with flap.}$$

$$c_{m_w} = \frac{m_w}{qc_w^2}, \text{ pitching-moment coefficient of main airfoil alone about quarter-chord point.}$$

$$c_{m(w+f)} = \frac{m_{(w+f)}}{qc_w^2}, \text{ pitching-moment coefficient of main airfoil with flap, about quarter-chord point of main airfoil.}$$

$$c_{n_f} = \frac{n_f}{qc_f}, \text{ normal-force coefficient of flap.}$$

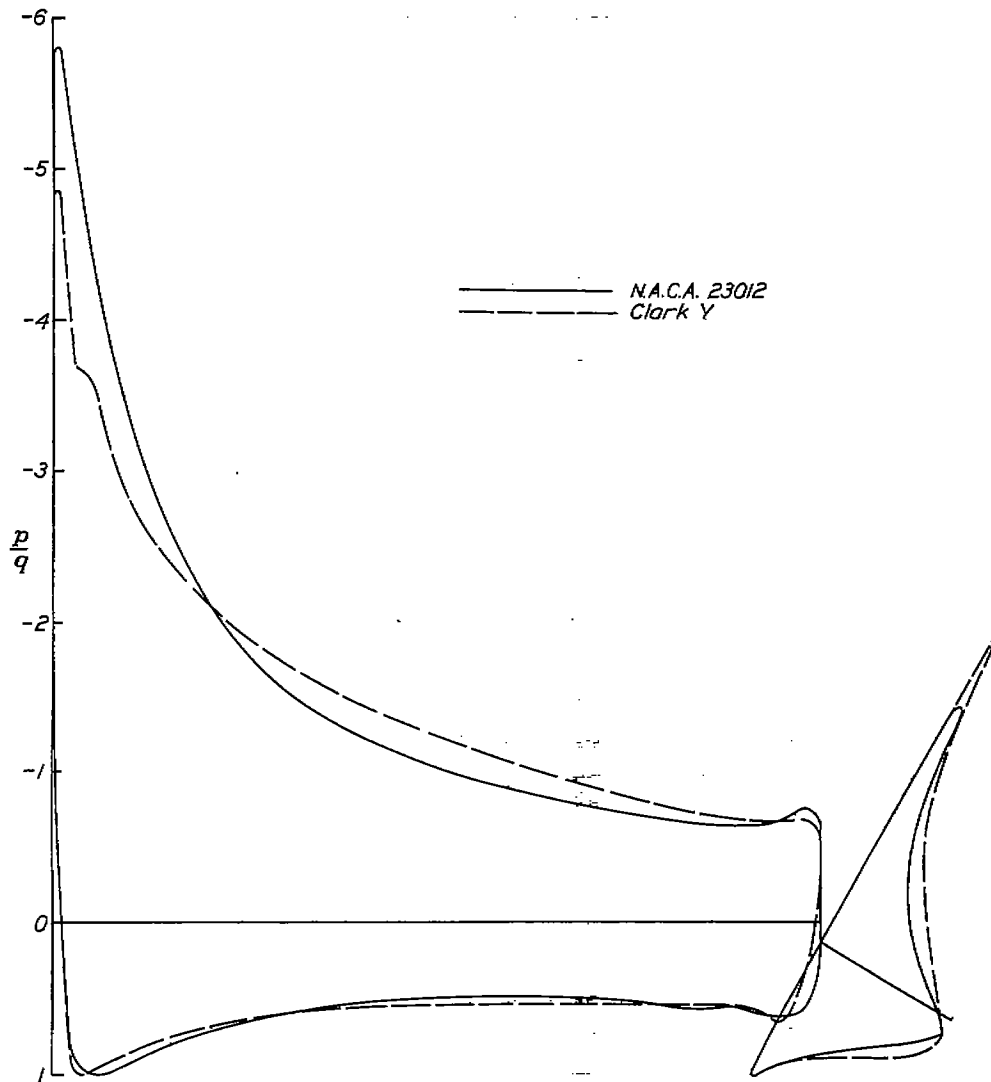

FIGURE 11.—Comparison of the pressure distribution, at the same lift, on the Clark Y airfoil and the $0.20c_w$ Clark Y Fowler flap with that on the N. A. C. A. 23012 airfoil and the $0.20c_w$ N. A. C. A. 23012 Fowler flap. $c_{n(w+f)} = 2.35$.

COEFFICIENTS

The pressure diagrams were mechanically integrated to obtain data from which section coefficients could be computed. The section coefficients are defined as follows:

$$c_{n_w} = \frac{n_w}{qc_w}, \text{ normal-force coefficient of main airfoil alone.}$$

$$c_{m_f} = \frac{m_f}{qc_f^2}, \text{ pitching-moment coefficient of flap about quarter-chord point of flap.}$$

$$(c.p.)_w = \left(0.25 - \frac{c_{m_w}}{c_{n_w}}\right) \times 100, \text{ center of pressure of main airfoil alone, in percentage of chord from leading edge.}$$

$(c.p.)_{(w+f)} = \left(0.25 - \frac{c_{m(w+f)}}{c_{n(w+f)}} \right) \times 100$, center of pressure of main airfoil with flap, in percentage of main-airfoil chord from leading edge.

m_w , pitching moment of main airfoil about quarter-chord point.
 $m_{(w+f)}$, pitching moment of main airfoil with flap about quarter-chord point of main airfoil.
 n_f , normal force of flap.
 m_f , pitching moment of flap about quarter-chord point of flap.

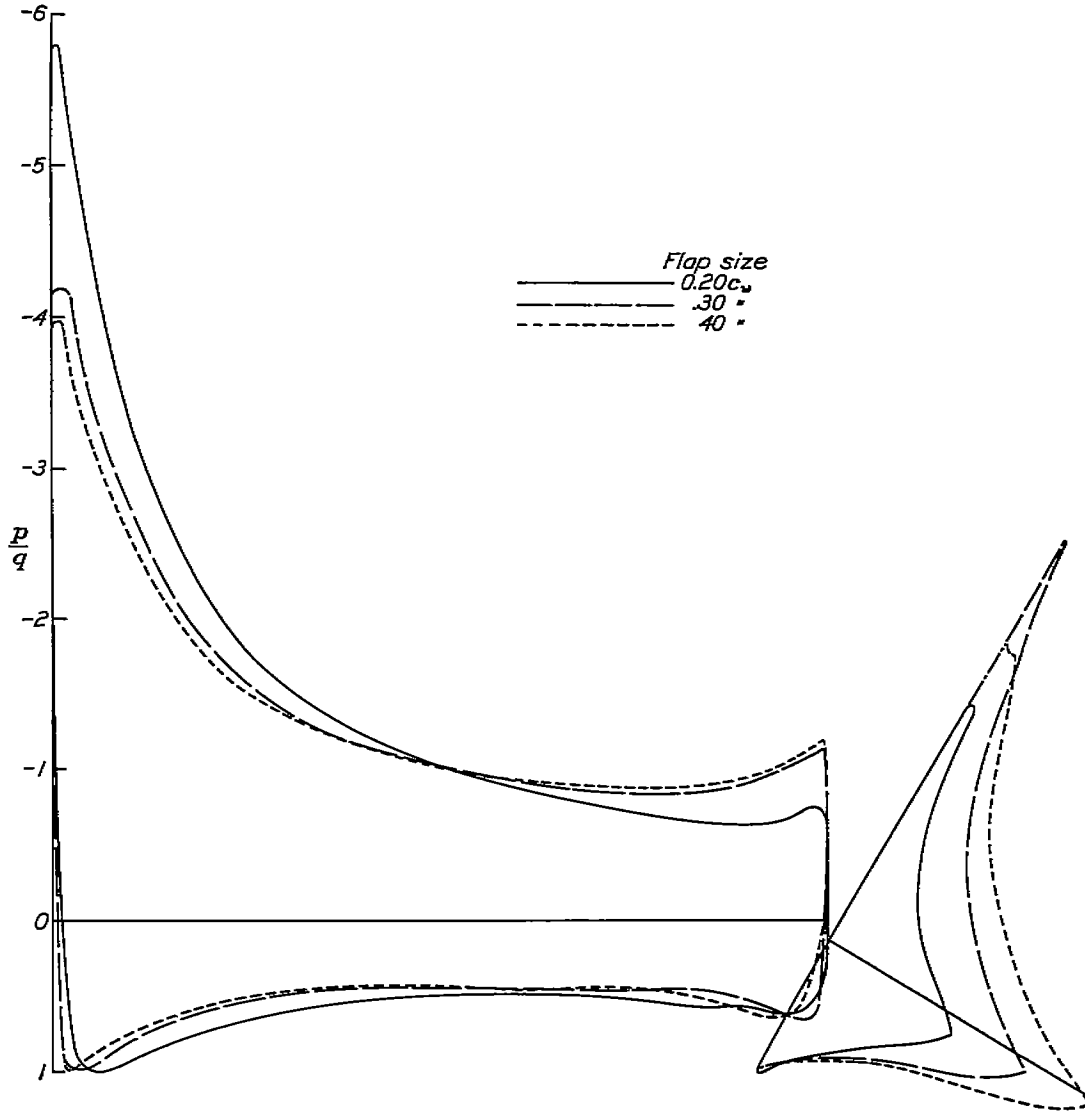

FIGURE 12.—Comparison of the pressure distribution, at the same lift, on the N. A. C. A. 23012 airfoil with the 0.20 c_w , the 0.30 c_w , and the 0.40 c_w N. A. C. A. 23012 Fowler flaps. $c_{n(w+f)} = 2.35$.

$(c.p.)_f = \left(0.25 - \frac{c_{m_f}}{c_{n_f}} \right) \times 100$, center of pressure of flap in percentage of flap chord from leading edge of flap.

$c_{c_f} = \frac{x_f}{q c_f}$, chord-force coefficient of flap.

where the forces per unit span are:
 n_w , normal force of main airfoil.
 $n_{(w+f)}$, normal force of main airfoil with flap.

x_f , chord force of flap.
 and
 q , dynamic pressure.
 c_w , main-airfoil chord.
 c_f , flap chord.

The center-of-pressure positions and the pitching-moment coefficients were derived from the normal forces, the chord forces being neglected except for the effect of the flap, in which case the flap deflection was taken into account.

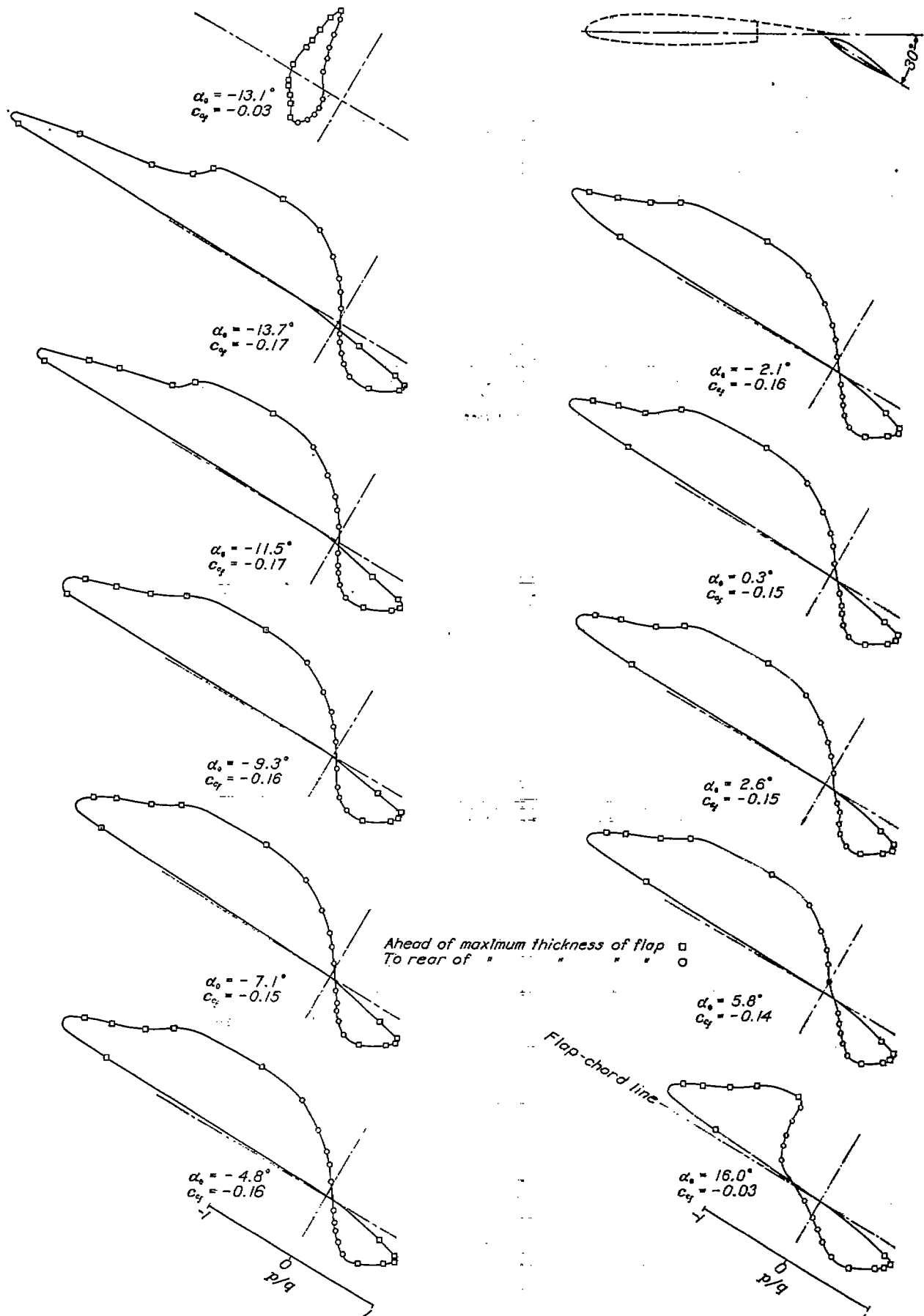

FIGURE 13.—Chord pressure distribution on the 0.30c N. A. C. A. 23012 Fowler flap mounted on the N. A. C. A. 23013 airfoil. Flap deflected 30°.

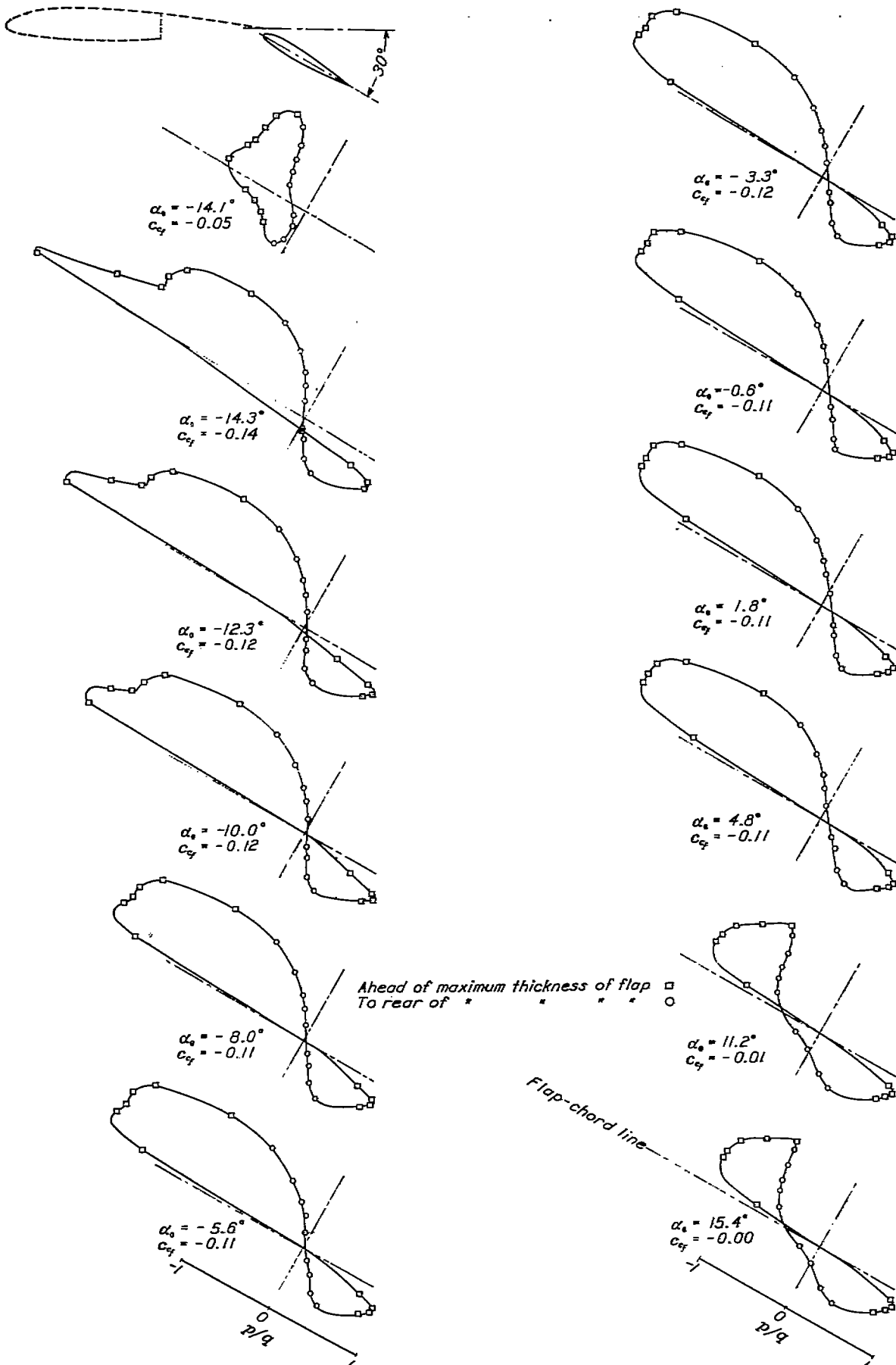

FIGURE 14.—Chord pressure distribution on the 0.40c N. A. C. A. 23012 Fowler flap mounted on the N. A. C. A. 23012 airfoil. Flap deflected 30°.

The calculated results from the present tests were all corrected to infinite aspect ratio in accordance with methods given by Glauert (reference 8). A check on the theoretical correction is shown in figure 15, where the corrected results of the pressure-distribution tests are compared with force-test results (reference 9) for a 10- by 60-inch N. A. C. A. 23012 plain wing corrected to infinite aspect ratio by the usual methods.

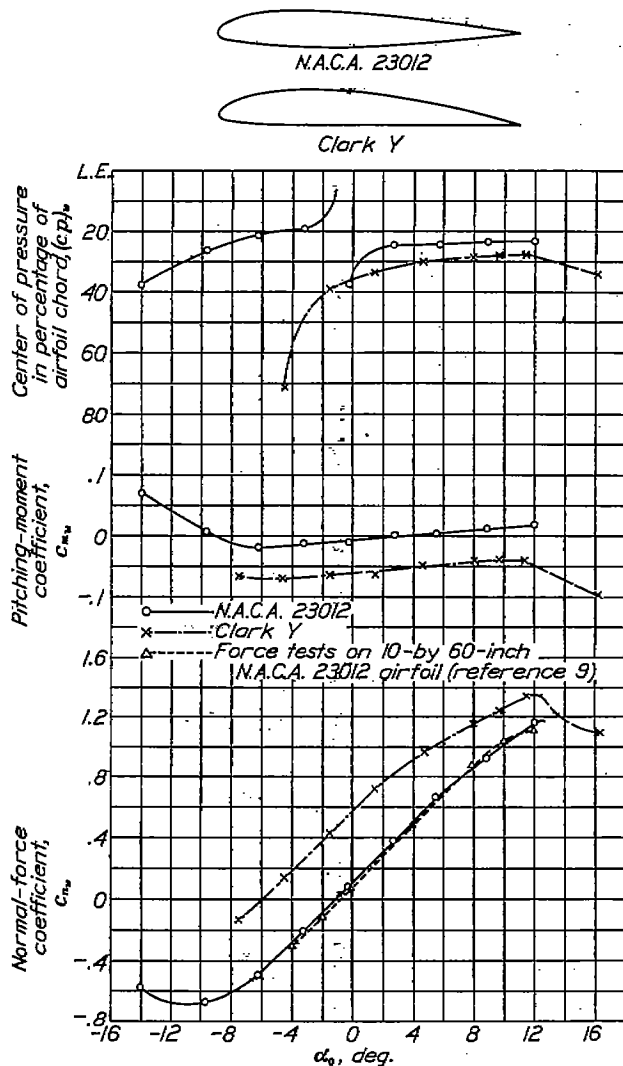

FIGURE 15.—Section characteristics of the N. A. C. A. 23012 and the Clark Y airfoils.

For the case of the pressure-distribution tests—

$$\alpha_0 = \alpha + \Delta\alpha$$

where

$$\Delta\alpha \text{ (deg.)} = -\left(0.25 \frac{c}{h} c_n\right) \times 57.3$$

c is the total chord.
 h , height of the jet.

(The quantity c_n is substituted for C_L in the present correction and the substitution results in only a slight error because of the small difference in value between the two quantities.) Curves of the various calculated coefficients are given in figures 15 to 18.

PRECISION

As no air-flow alignment tests were made in either wind tunnel with the test arrangements used in the investigation, the absolute setting of the angle of attack may be slightly in error; the relative angles are, however, accurate to within $\pm 0.1^\circ$. The flaps were set to the specified angle to within $\pm 0.1^\circ$. The orifice pressures based on check tests in which the angles of attack were changed showed that they agreed to within ± 2 percent, with the exception of upper-surface pressures near the leading edges, which, at high angles of attack, checked within ± 5 percent. The dynamic pressure recorded on each diagram was accurate to within ± 0.25 percent for all tests. Pressure orifices were not sufficiently numerous to determine the peak pressures accurately at the airfoil nose, but this fact should not appreciably affect the results.

RESULTS AND DISCUSSION

SECTION PRESSURE DISTRIBUTION

The pressure-distribution diagrams (figs. 5 to 14) show the distribution of the air loads on the main airfoils and on the flaps and may be considered satisfactory for application to rib and flap design. The diagrams of forces normal to the chord shown in figures 7 to 10 are very similar to those for an airfoil with an external-airfoil flap (reference 4), indicating that the effects produced by the Fowler flap and by the external-airfoil flap are very much alike.

Comparison of the normal-pressure diagram for the N. A. C. A. 23012 airfoil and N. A. C. A. 23012 Fowler flap with that for the Clark Y airfoil and Clark Y Fowler flap at the same total lift (fig. 11) shows the effect of changes in airfoil section. Changing from a Clark Y to an N. A. C. A. 23012 section for both main airfoil and flap had the following effects: (1) The loads on the flap were reduced and (2) the adverse pressure gradients of the main airfoil, and thereby its tendency to stall, were increased.

Comparison of normal-pressure diagrams for the N. A. C. A. 23012 airfoil with various sizes of N. A. C. A. 23012 Fowler flap (fig. 12) shows the effect of changing the flap chord for a given lift of the combination. Increasing the flap chord had the following effects: (1) The portion of the load carried by the flap was increased; and (2) the adverse pressure gradients of the main airfoil were decreased so that higher lifts could be obtained before stalling.

The chord pressure diagrams for the $0.30c_n$ and $0.40c_n$ Fowler flaps (figs. 13 and 14) were included because it was thought that relatively large forces existed which acted in a direction to retract the flap from its maximum-lift setting. As indicated by these diagrams, the negative component overbalances the positive for practically all of the arrangements tested, so that the total chord pressure force is directed forward. This force, however,

does not include the skin-friction forces, which also act nearly parallel to the chord and in such a way as to increase the magnitude of the total chord force if positive or to decrease it if negative.

Fowler flap gives a higher maximum lift than the N. A. C. A. 23012 airfoil with N. A. C. A. 23012 Fowler flap (fig. 16). This fact is partly accounted for, however, by the higher maximum lift of the plain Clark Y

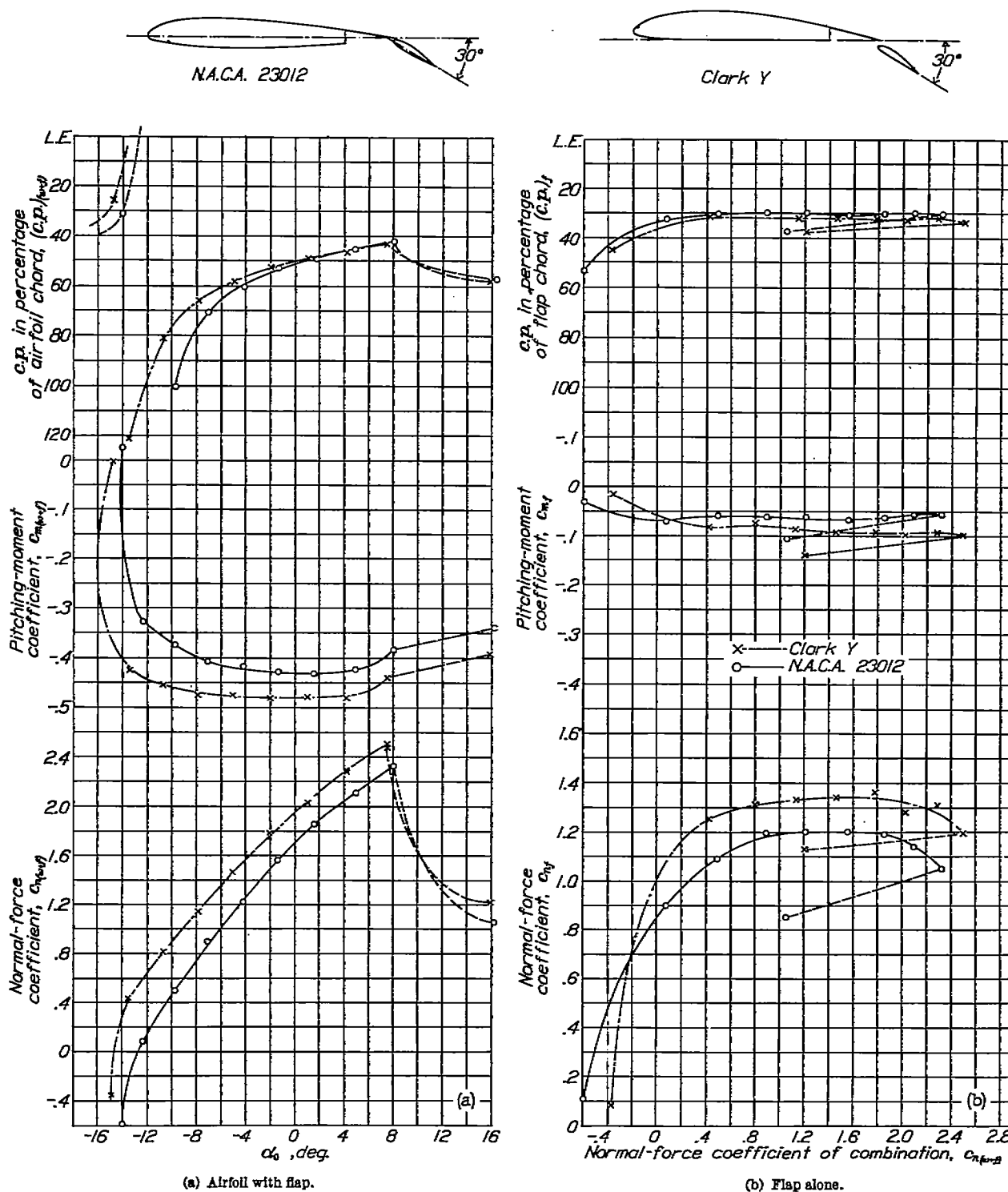

FIGURE 16.—Section characteristics of the N. A. C. A. 23012 airfoil with the 0.20c_u N. A. C. A. 23012 Fowler flap and of the Clark Y airfoil with the 0.20c_u Clark Y Fowler flap. Flaps deflected 30°.

SECTION LOADS AND MOMENTS

Pressure-distribution results.—The airfoil and flap section coefficients are given in figures 15 to 18. It will be noted that the Clark Y airfoil with Clark Y

airfoil at the Reynolds Numbers of the tests, the increment in maximum lift due to the flap being approximately the same with either airfoil combination. In addition, the normal-force coefficients of the Clark

Y Fowler flap are somewhat higher than those of the N. A. C. A. 23012 flap.

In all the arrangements investigated, the flap loads build up rapidly at relatively low lifts of the combina-

airfoil flap (reference 4) and also for simple split flaps (references 10 and 11).

The chord-force coefficients of the Fowler flaps (figs. 17 and 18) are all negative in sign; that is, the

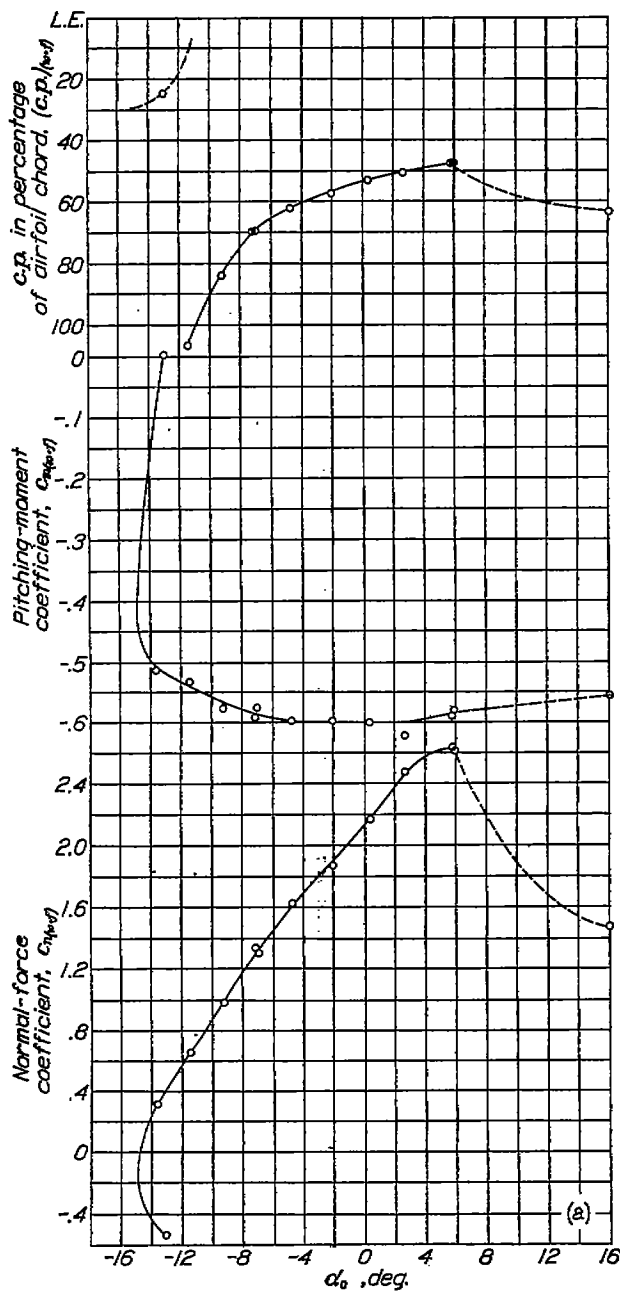
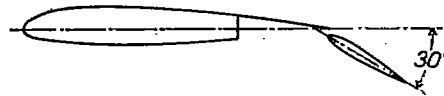

(a) Airfoil with flap.

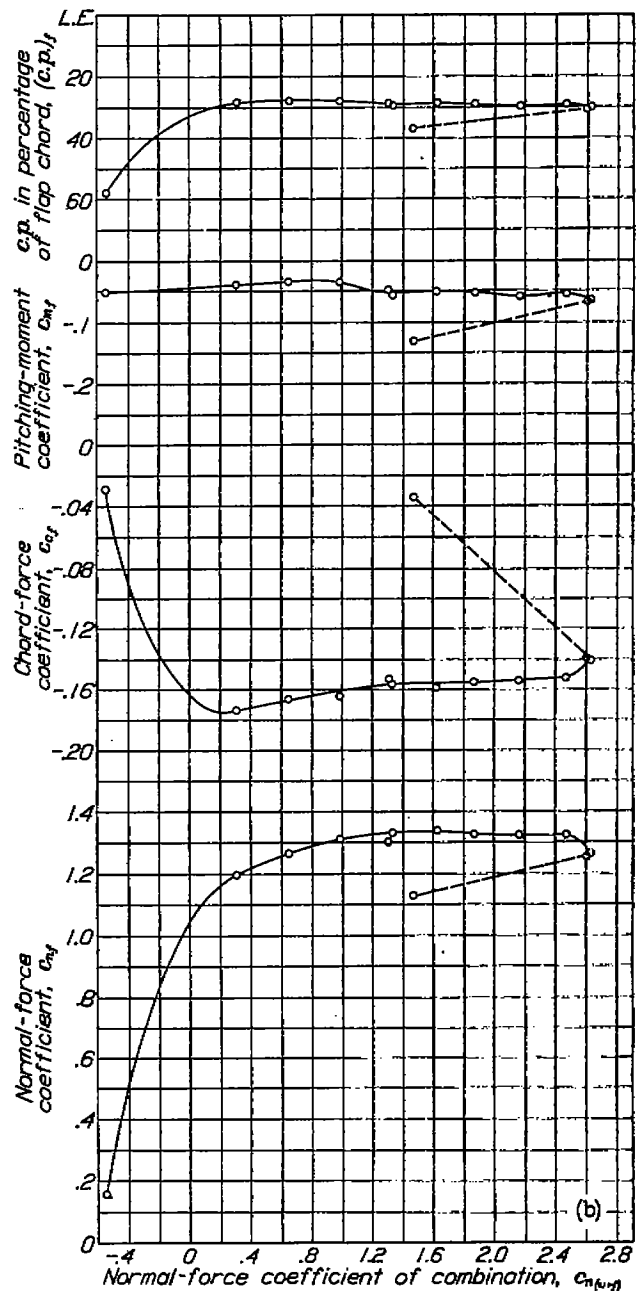

(b) Flap alone.

FIGURE 17.—Section characteristics of the N. A. C. A. 23012 airfoil with the 0.30c_w N. A. C. A. 23012 Fowler flap. Flap deflected 30°.

tion, but the normal-force coefficients do not differ greatly for the three sizes of N. A. C. A. 23012 Fowler flap. The range of the maximum values of the Fowler flap normal-force coefficient is from 1.20 to 1.33, which approximates the maximum values for the external-

pressure forces parallel to the chord are directed forward along the chord. The magnitudes of these forces are relatively small and, as previously mentioned, they would be decreased by the skin-friction forces that have not been included.

Comparison with force-test measurements of flap loads.—A comparison of some loads on Fowler flaps obtained from force-test measurements in an earlier investigation (reference 1) with those from the present

pendently of the main airfoil at the position and angle for maximum lift and then measuring the forces on the airfoil alone mounted on the balance in the presence of the flap. The flap loads were then computed by

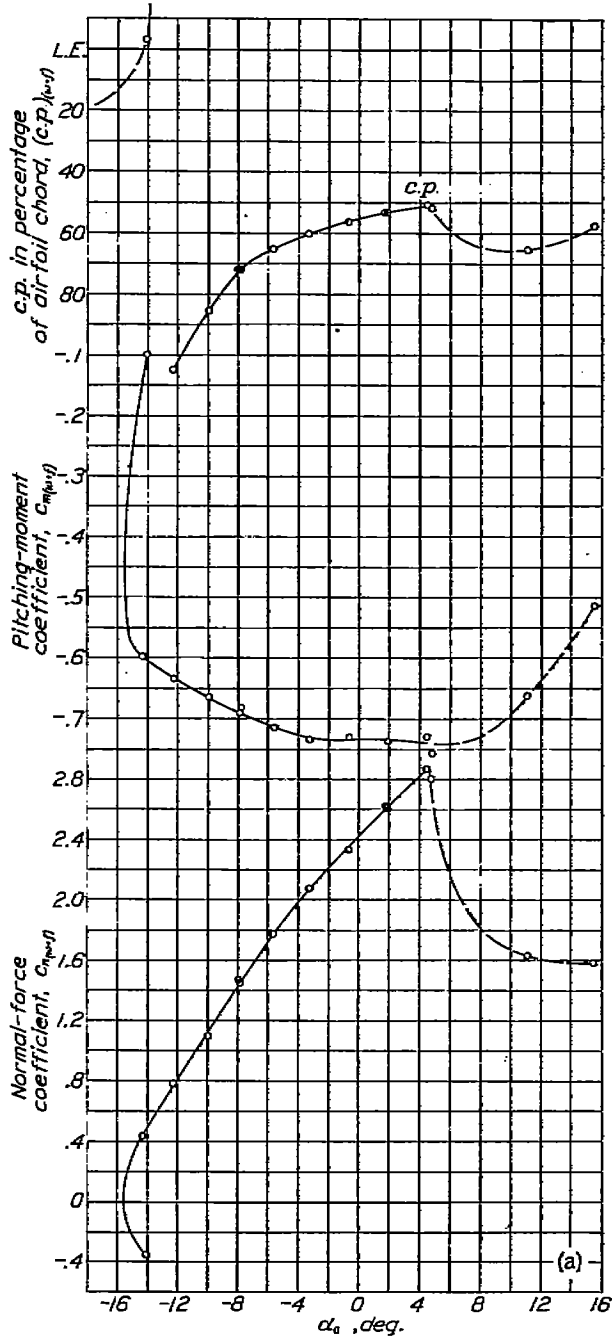
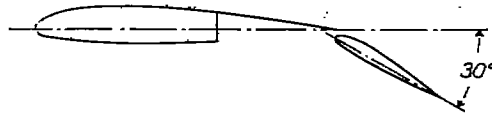

(a) Airfoil with flap.

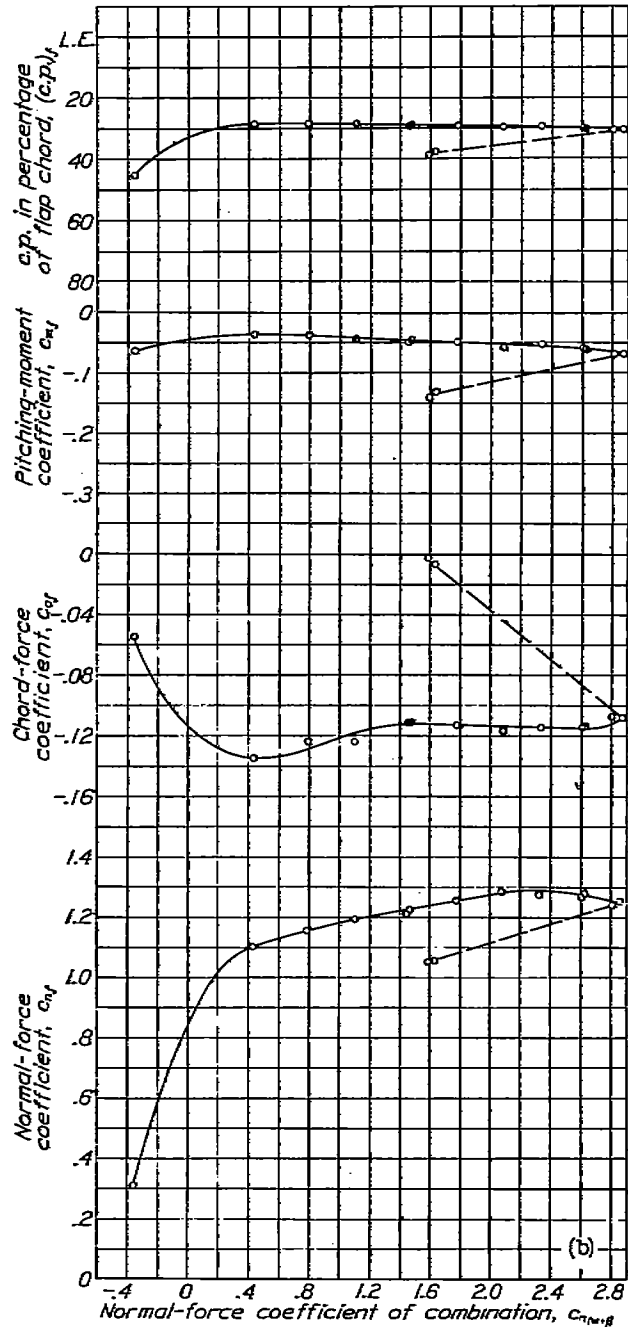

(b) Flap alone.

FIGURE 13.—Section characteristics of the N. A. C. A. 23012 airfoil with the 0.40c_N N. A. C. A. 23012 Fowler flap. Flap deflected 30°.

pressure-distribution measurements indicates that a serious disagreement exists between the two. In the case of the force tests, air loads acting on the Fowler flaps were determined by supporting the flaps inde-

pendently of the main airfoil at the position and angle for maximum lift and then measuring the forces on the airfoil alone mounted on the balance in the presence of the flap from those on the main airfoil with the flap attached.

The disagreement between the results from the two

types of test has been found traceable to deflections of the model in the force tests (reference 1) resulting in displacement of the flap with respect to the main airfoil. The combination thus failed to develop the full lift coefficient available when set up for the flap-load tests, thereby resulting in the observation of small forces on the main airfoil with the flap separately supported. The resulting flap loads, calculated as previously described, were consequently considerably exaggerated. The present pressure-distribution results, however, are believed reliable in view of the test methods and the rigid models used in the investigation and should therefore be considered as superseding the flap-load data given in reference 1.

CONCLUSIONS

1. The pressure-distribution tests show that the effect of increasing the chord of the Fowler flap, for a given lift of combined main airfoil and flap, was to increase the portion of the total load carried by the flap and to decrease the adverse pressure gradients of the main airfoil and thereby its tendency to stall.

2. The maximum values of normal-force coefficient of the Fowler flap are much smaller than previously indicated and are approximately the same as those of the external-airfoil flap and of the simple split flap.

LANGLEY MEMORIAL AERONAUTICAL LABORATORY,
NATIONAL ADVISORY COMMITTEE FOR AERONAUTICS,
LANGLEY FIELD, VA., November 24, 1937.

REFERENCES

1. Platt, Robert C.: Aerodynamic Characteristics of a Wing with Fowler Flaps Including Flap Loads, Downwash, and Calculated Effect on Take-Off. T. R. No. 534, N. A. C. A., 1935.
2. Weick, Fred E., and Platt, Robert C.: Wind-Tunnel Tests of the Fowler Variable-Area Wing. T. N. No. 419, N. A. C. A., 1932.
3. Weick, Fred E., and Platt, Robert C.: Wind-Tunnel Tests on Model Wing with Fowler Flap and Specially Developed Leading-Edge Slot. T. N. No. 459, N. A. C. A., 1933.
4. Wenzinger, Carl J.: Pressure Distribution over an N. A. C. A. 23012 Airfoil with an N. A. C. A. 23012 External-Airfoil Flap. T. R. No. 614, N. A. C. A., 1938.
5. Harris, Thomas A.: The 7 by 10 Foot Wind Tunnel of the National Advisory Committee for Aeronautics. T. R. No. 412, N. A. C. A., 1931.
6. Wenzinger, Carl J., and Harris, Thomas A.: The Vertical Wind Tunnel of the National Advisory Committee for Aeronautics. T. R. No. 387, N. A. C. A., 1931.
7. Platt, Robert C.: Turbulence Factors of N. A. C. A. Wind Tunnels as Determined by Sphere Tests. T. R. No. 558, N. A. C. A., 1936.
8. Glauert, H.: Wind Tunnel Interference on Wings, Bodies, and Airscrews. R. & M. No. 1560, British A. R. C., 1933.
9. Wenzinger, Carl J.: Wind-Tunnel Investigation of Ordinary and Split Flaps on Airfoils of Different Profile. T. R. No. 554, N. A. C. A., 1936.
10. Wenzinger, Carl J.: Wind-Tunnel Measurements of Air Loads on Split Flaps. T. N. No. 498, N. A. C. A., 1934.
11. Wenzinger, Carl J., and Harris, Thomas A.: Pressure Distribution over a Rectangular Airfoil with a Partial-Span Split Flap. T. R. No. 571, N. A. C. A., 1936.

TABLE I

ORDINATES AND ORIFICE LOCATIONS OF AIRFOIL AND FOWLER FLAP COMBINATIONS TESTED

(a)

Clark Y airfoil: Section ordinates in percent of chord

Station	Upper	Lower
0	3.60	3.60
1.25	5.33	1.86
2.5	6.43	1.42
5	7.93	.91
7.5	8.79	.59
10	9.56	.39
15	10.63	.12
20	11.32	.01
30	11.63	.00
40	11.37	.00
50	10.49	.00
60	9.13	.00
70	7.34	.00
80	5.21	.00
90	2.79	.00
95	1.50	.00
100	.12	.00

(b)

Clark Y 20-inch airfoil, plain and with 0.20c_w flap: Orifice locations on surfaces in percent of chord from leading edge

Orifice	Upper	Lower
0	0.00	0.00
1	2.50	2.50
2	5.00	5.00
3	10.00	10.00
4	25.00	25.00
5	45.00	45.00
6	62.50	62.50
7	75.00	75.00
8	85.00	85.00
9	90.00	90.00
10	95.00	95.00
11	99.00	99.00

(c)

Clark Y 0.20c_w flap: Orifice locations on surfaces in percent of flap chord from leading edge

Orifice	Upper	Lower
0	0.00	0.00
1	2.50	2.50
2	5.00	5.00
3	10.00	10.00
4	25.00	25.00
5	45.00	45.00
6	62.50	62.50
7	75.00	75.00
8	82.50	82.50
9	92.50	92.50

(d)

N. A. C. A. 23012 airfoil: Section ordinates in percent of chord

Station	Upper	Lower
0		
1.25	2.67	-1.23
2.5	3.61	-1.71
5	4.91	-2.26
7.5	5.50	-2.61
10	6.43	-2.92
15	7.19	-3.50
20	7.60	-3.97
25	7.60	-4.23
30	7.55	-4.46
40	7.14	-4.45
50	6.41	-4.17
60	5.47	-3.67
70	4.36	-3.00
80	3.08	-2.16
90	1.68	-1.23
95	.92	-.70
100	.13	-.13

L. E. radius=1.68
Slope through zero=0.305

(e)

N. A. C. A. 23012 20-inch plain airfoil: Orifice locations on surfaces in percent of chord from leading edge

Orifice	Upper	Lower
0	0.00	0.00
1	2.40	2.40
2	5.00	5.00
3	10.00	10.00
4	25.00	25.00
5	45.00	45.00
6	62.50	62.50
7	75.00	75.00
8	82.50	82.50
9	88.10	88.10
10	93.60	93.60
11	98.60	98.60

(f)

N. A. C. A. 23012 0.20c_w flap: Orifice locations on surfaces in percent of flap chord from leading edge

Orifice	Upper	Lower
0	0.00	0.00
1	2.50	2.50
2	5.00	5.00
3	10.00	10.00
4	25.00	25.00
5	45.00	45.00
6	62.50	62.50
7	75.00	75.00
8	82.50	82.50
9	92.50	92.50

(g)

N. A. C. A. 23012 20-inch airfoil with 0.20c_w and 0.30c_w flaps: Orifice locations on surfaces in percent of chord from leading edge

Orifice	Upper	Lower
0	0.00	0.00
1	2.40	2.40
2	5.00	5.00
3	10.00	10.00
4	25.00	25.00
5	45.00	45.00
5a	none	58.80
6	62.50	62.50
6a	none	68.80
7	75.00	75.00
8	82.50	82.50
9	88.10	88.10
10	93.60	93.60
11	98.60	98.60

(h)

N. A. C. A. 23012 20-inch airfoil with 0.40c_w flap: Orifice locations on surfaces in percent of chord from leading edge

Orifice	Upper	Lower
0	0.00	0.00
1	2.40	2.40
2	5.00	5.00
3	10.00	10.00
4	25.00	25.00
5	45.00	45.00
5a	none	58.80
6	62.50	62.50
7	75.00	75.00
8	82.50	82.50
9	88.10	88.10
10	93.60	93.60
11	98.60	98.60

(i)

N. A. C. A. 23012 0.30c_w and 0.40c_w flaps: Orifice locations on surfaces in percent of flap chord from leading edge

Orifice	Upper	Lower
0	0.00	0.00
1	1.20	1.20
2	2.50	2.50
3	5.00	5.00
4	10.00	10.00
5	25.00	25.00
6	45.00	45.00
7	62.50	62.50
8	75.00	75.00
9	82.50	82.50
10	92.50	92.50